



Unit 38 The Warren, Eastgoscote Industrial Estate, Leicester, Leicestershire, LE7 3XA, UK
+44116 2692212 / 0116 2692212, www.curvomatic.com



0116 2692212
www.curvomatic.com

Born from the need to make accurate curved panels without the usual expense and waste.

Curvomatic uses a fraction of the materials and time involved with the more traditional techniques for laminating and thermoforming.

This is not however at the expense of quality!

Curvomatic extrusions will last a lifetime all the while giving superior results to most other methods.



Curvomatic is a modular structural sheet material, constructed by sliding together longitudinally hinging aluminium extrusions. The extrusions join with each other without limit to produce a flexible aluminium skin 35mm thick with a **minimum radius of 40mm**. This skin when screwed to curved formers, creates an incredibly rigid curved surface that can be used to form other materials to a very high level of accuracy. It also provides an amazingly effective clamping system.

We sell both variable length, modular kits for bespoke work as well as fixed length kits for regular work. The kits are constructed from our 18mm extrusion and will make moulds down to 185mm radius. For tighter radius sections you simply slide in the smaller radius extrusions where required.

Curvomatic can be used to make one or two sided moulds depending on the application. Pretty much any shape is achievable with a little creative clamping!



All the systems shown on this page were made with 3 modules of our variable length, modular system with the addition of some of our smaller radius extrusions.



We sell both long and short handled **5000Kg** ratchet sets. The long handled versions are great for heavy duty work.

No need to rely on expensive and poor quality, flexible plywoods. Curvomatic presses can form anything that will bend, being able to apply many times atmospheric pressure without damage

Image on left shows 4 layers of 6mm ply laminated to 700mm rad.

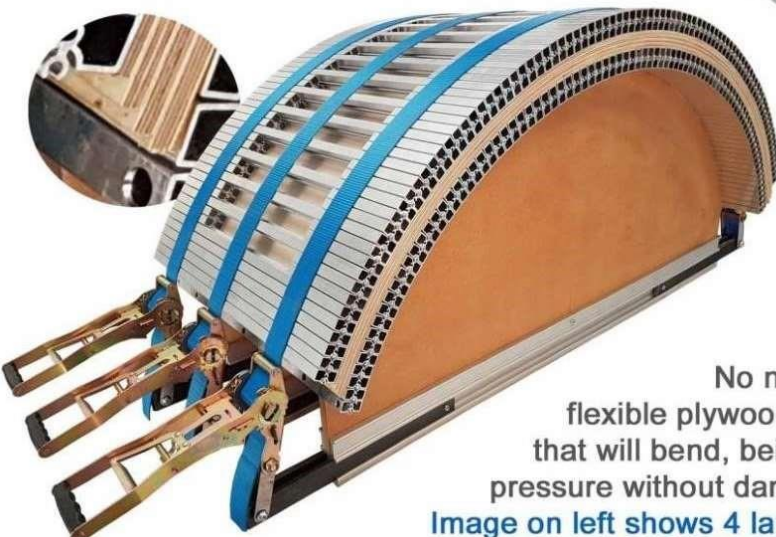

All the kits on our website are double hollow which is to say that there are two gaps in the centre sections. This is the best set up for general high quality work. All the kits can be reconfigured with one or no gaps if you are applying veneers. This will of coarse reduce the working width. Single hollow (one gap) and solid kits (no gaps) are available upon request but are only nessesary if you usually apply a thin surface veneer as part of a lamination.



With enough strength and versatility for any job, our extruded beams make the whole process much quicker than using wooden beams. **They are not however essential!** The beams are 1220mm long and extend with sliders to 1700mm. The formers sit into a deep slot and are fixed to the beams with a grub screw. To deal with even the largest projects, the beams join end to end with the sliding steel bars, as seen bottom left.

The sliding steel bars make positioning the ratchets very quick and simple and also give you fixings for extra ratchet plates.



Curvomatic extrusions can be used with wooden beams.

Due to aluminium's heat absorbing nature, **Curvomatic can be heated** by simply pointing a fan heater at it. By increasing the temperature you can get many more pressings per day than by pressing cold.

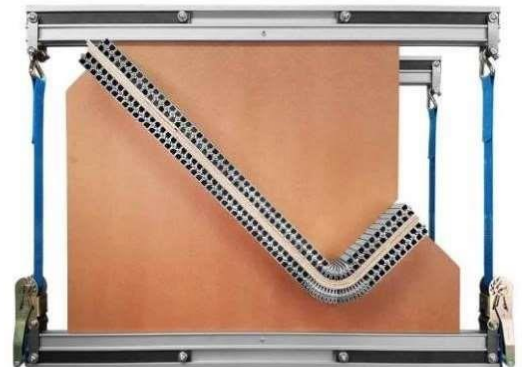
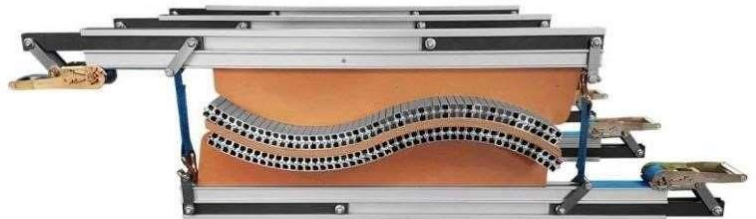

Big panels are not a problem! Molds can be made quickly even for the largest work and then stored flat rather than taking up huge amounts of valuable workshop space

Curvomatic moulds use at least **90% less materials** than other traditional methods of mould construction so If you are looking for green credentials for your manufacturing equipment then this is deffinitely the system for you.

Curvomatic vacuum forming moulds are constructed from 610mm (2') and 305mm (1') lengths of extrusion in a half overlay pattern. The system easily makes moulds at any length in 305mm (1') increments and any width in 18mm increments. The modular vacuum kits are constructed from our 18mm extrusion and will make moulds down to a **minimum radius of 185mm**. For tighter radius sections we have two smaller extrusions that can be added where required.



The permeable surface allows air to pass through. This means that even with very complex shapes, **you will not have to use breather strips, just a hole in the back board!**

Due to aluminium's heat absorbing nature, hot plastics will cool evenly and rapidly, without curling! **This allows more pressings per day than any other method.**

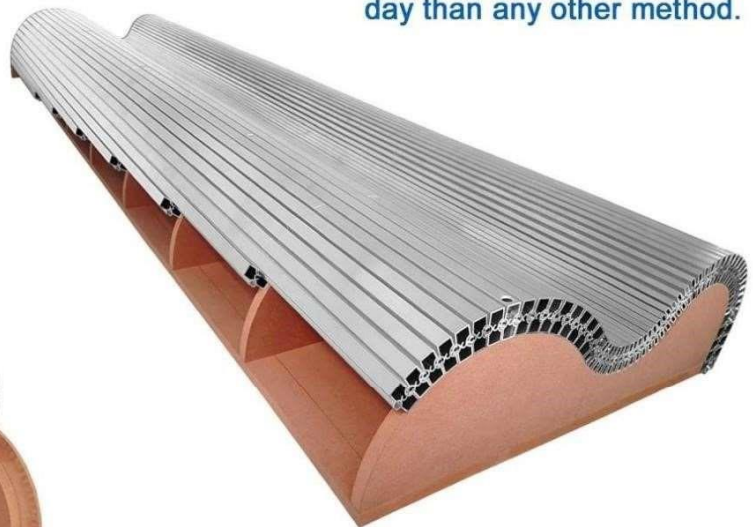
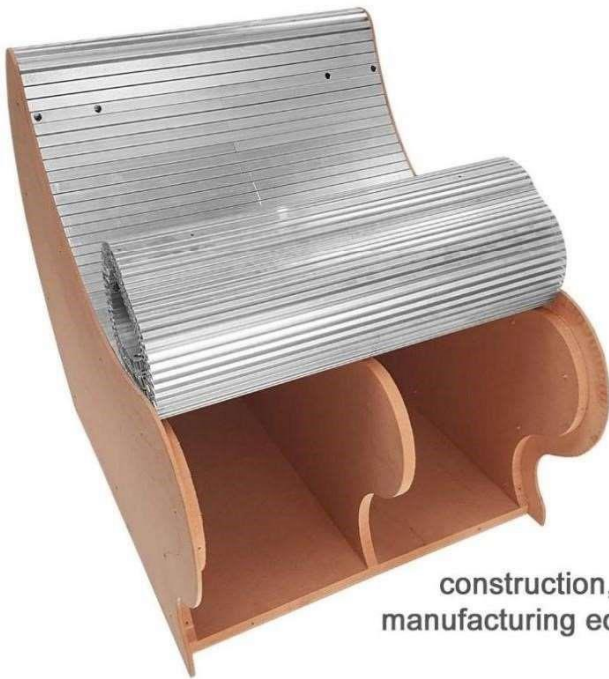

Curvomatic moulds use at least 90% less materials than other traditional methods of mould construction, so if you are looking for green credentials for your manufacturing equipment then this is definitely the system for you.

General instructions - <https://www.youtube.com/watch?v=YgW2zeqCNd8&t=474s>
Modular kits assembly - <https://www.youtube.com/watch?v=nHbS3JJTND> Main
Youtube channel - <https://www.youtube.com/user/niche1975>

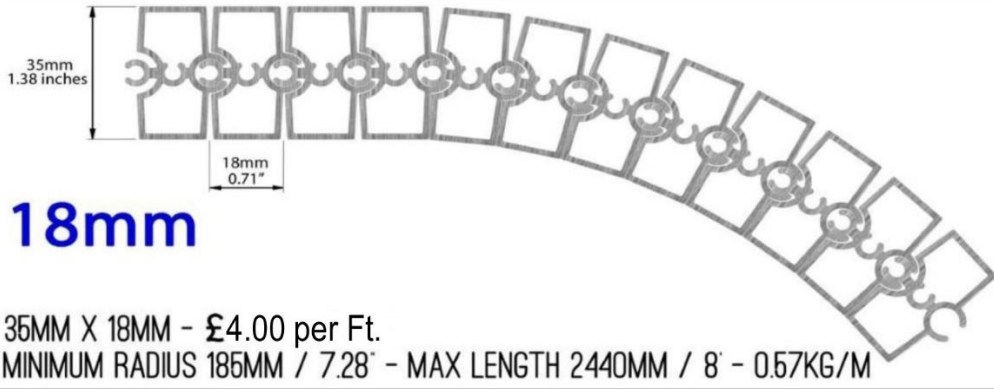

18mm

35MM X 18MM - £4.00 per Ft.
 MINIMUM RADIUS 185MM / 7.28' - MAX LENGTH 2440MM / 8' - 0.67KG/M

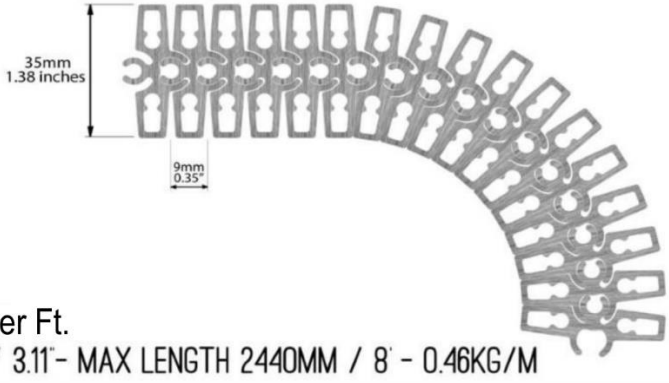

9mm

35MM X 9MM - £3.40 per Ft.
 MINIMUM RADIUS 79MM / 3.11' - MAX LENGTH 2440MM / 8' - 0.46KG/M



25°

35MM X 10MM @ 25° - £4.00 per Ft.
 MINIMUM RADIUS 40MM / 1.57' - MAX LENGTH 2440MM / 8' - 0.48KG/M



NEW PRODUCT One Inch

This is a stand alone lightweight system
 To be used only in a solid configuration
 Best for vacuum forming moulds and thermoforming
 25.4MM X 16MM - £3.30 per Ft.
 MINIMUM RADIUS 38MM / 1.48' - MAX LENGTH 2440MM / 8' - 0.33KG/M

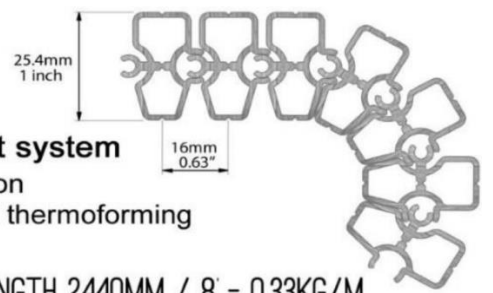

Clamping Beam

90MM X 46MM
 1220MM / 4' - £100
 2440MM / 8' - £200
 AVAILABLE ONLY @ 1220MM AND 2440MM / 4' AND 8' - 4.8KG/M

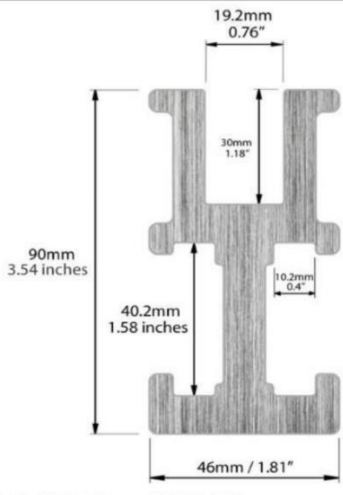

Clamping Beam Kit

1220MM / 4' BEAMS WITH 400MM SLIDERS AND FITTING

£140.00



Ratchet Set

2 X RATCHET HANDLE
2.5M OF 50MM WEBBING

£35.00



Ratchet Attachment Plates

4 X STEEL PLATES - 3MM X 25MM X 90MM

£12.00



Box of 1000 Screws

8 X 3/4" PAN HEADS FOR 35MM EXTRUSIONS
KITS ALL COME WITH SCREWS INCLUDED

£30.00



Fixed Length Kits

Fixed length kits made from our 35mm x 18mm extrusions are available in any size up to 10' / 3050mm in length and at any width.

The same kit can be reconfigured with no gaps and with up to 3 gaps.

Tighter radius sections can be added by using our 9mm and 25° extrusions.

No gaps "Solid (S)" is best for thermoforming. The 9mm and 25° extrusions are used solid.

One gap "Single Hollow (SH)" are the best set up for veneering

Two gaps "Double Hollow (DH)" is the standard configuration for most laminating work

Three gaps "Triple Hollow (TH)" is suitable for wall panels and upholstered work.

Tell us your requirements and we will give you our best quote for your most suitable set up.

Kits are usually quoted without Beams or ratchets.

For example, an 8' x 4' Double Hollow (DH) kit costs £2336.00

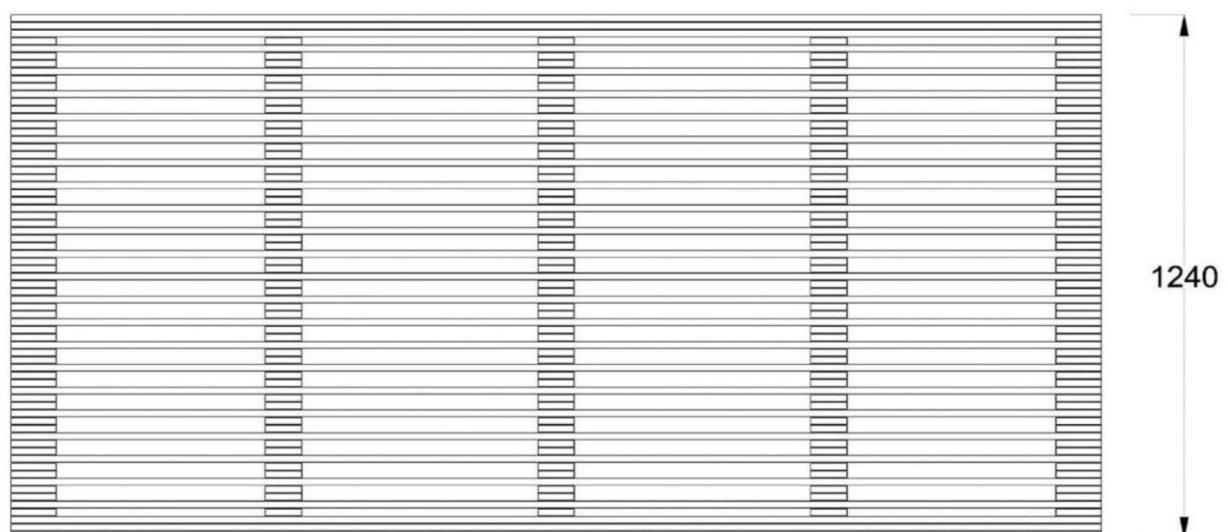
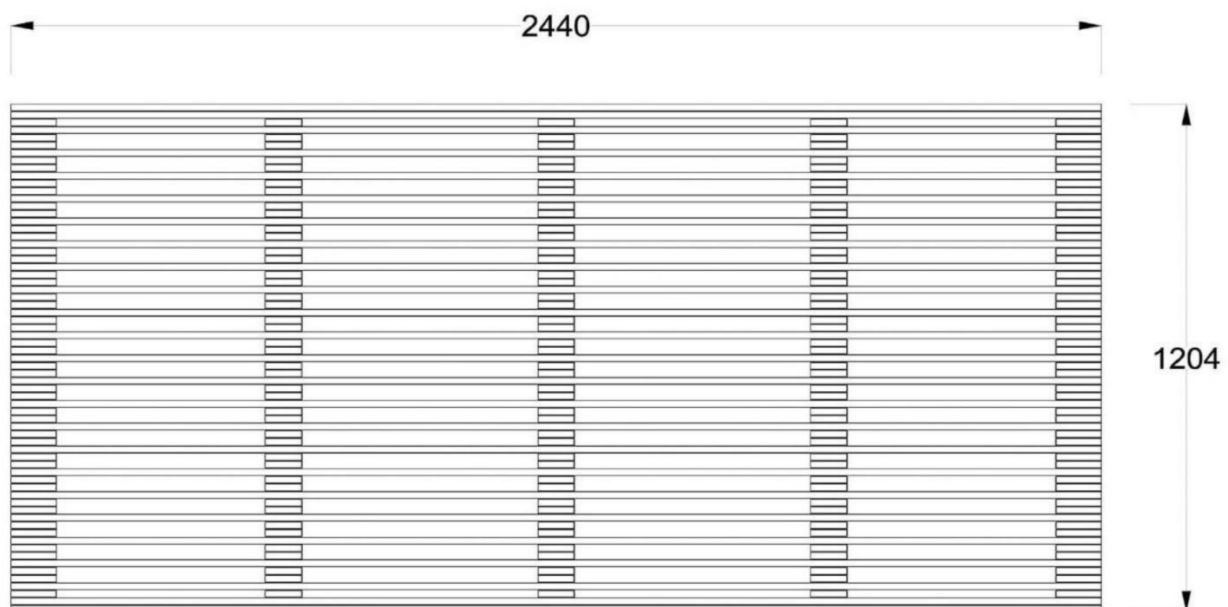

Double Hollow Pressing Module

18MM X 35MM EXTRUSIONS - MINIMUM RADIUS 185MM

£375.00

24 @ 2' / 610mm

88 @ 6" / 152mm

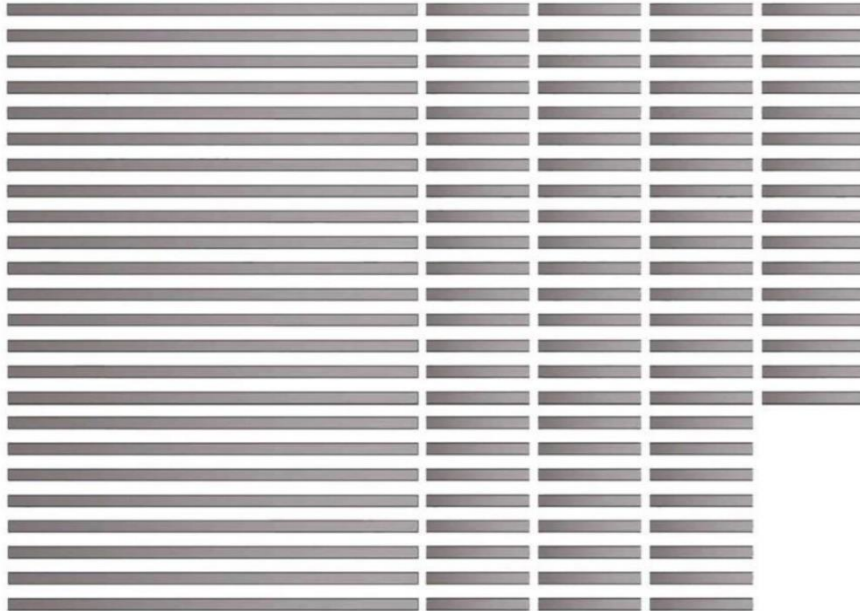

Module Joining Kit

18MM X 35MM EXTRUSIONS - MINIMUM RADIUS 185MM

£330.00

3 drilled @ 2' / 610mm



3 drilled @ 4' / 1220mm



3 drilled @ 6' / 1830mm



3 @ 2' / 610mm



3 @ 4' / 1220mm



3 @ 6' / 1830mm



Modular Kit Sizes

Dimensions stated show the size of panel that can be formed

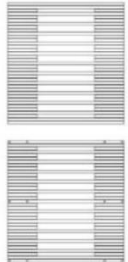

610mm x 664mm
2' x 2' 2 1/4"

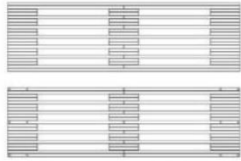

1220mm x 378mm
4' x 1' 2 7/8"



1830mm x 270mm
6' x 10 5/8"

1 module + joining kit
£705.50



610mm x 1278mm
2' x 4' 2 5/16"

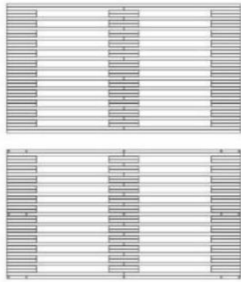

1220mm x 702mm
4' x 2' 3 5/8"

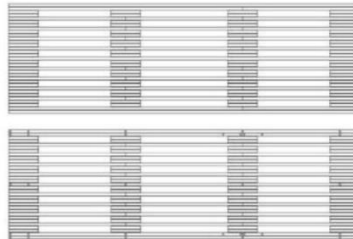

1830mm x 594mm
6' x 1' 11 3/8"

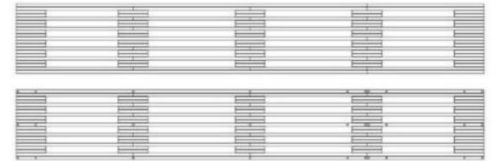

2440mm x 378mm
8' x 1' 2 7/8"

2 modules + joining kit
£1081.00

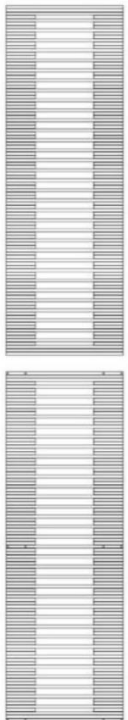

610mm x 1890mm
2' x 6' 2 13/32"

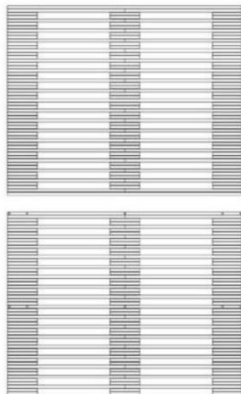

1220mm x 1026mm
4' x 3' 4 25/64"

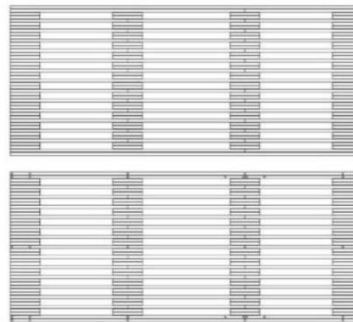

1830mm x 810mm
6' x 2' 7 57/64"

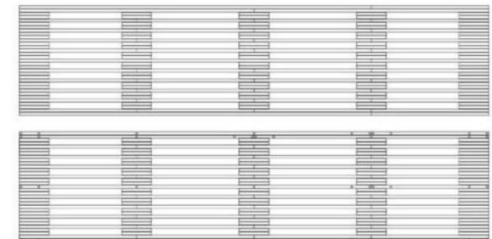

2440mm x 594mm
8' x 1' 11 25/64"

3 modules + joining kit
£1456.50



2' x 8' 1 3/32"
610mm x 2466mm



4' x 4' 5 5/32"
1220mm x 1350mm

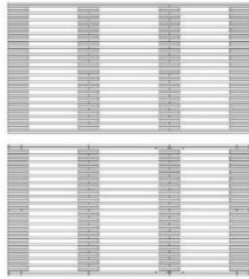

6' x 3' 4 25/64"
1830mm x 1026mm



8' x 2' 3 5/8"
2440mm x 702mm

4 modules + joining kit
£1832.00



2' x 10' 1 3/16"
610mm x 3078mm

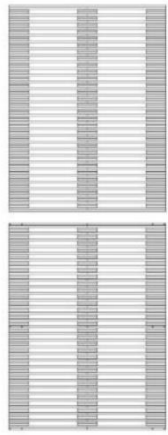

4' x 5' 4 31/64"
1220mm x 1638mm

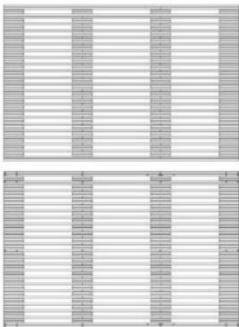

6' x 4' 57/64"
1830mm x 1242mm

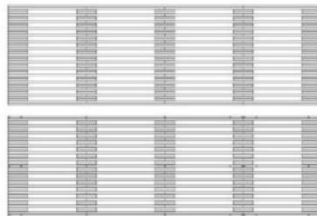

8' x 2' 7 57/64"
2440mm x 810mm

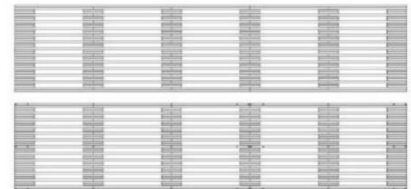

10' x 2' 3 5/8"
3050mm x 702mm

5 modules + joining kit
£2207.50

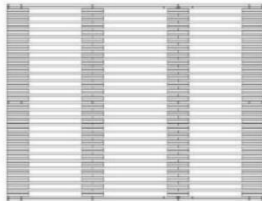
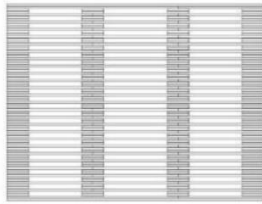
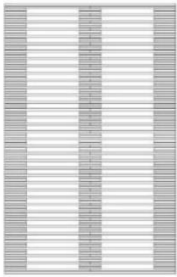

6' x 4' 9 13/32"
1830mm x 1458mm

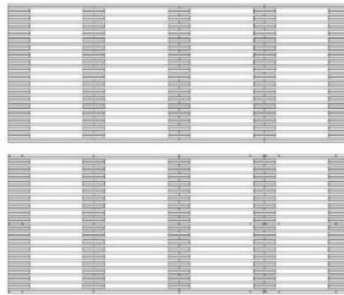

8' x 3' 4 25/64"
2440mm x 1026mm

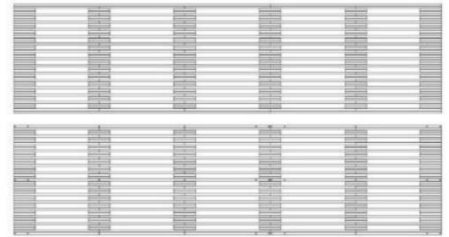

10' x 2' 7 57/64"
3050mm x 810mm



4' x 6' 6 21/32"
1220mm x 1998mm

6 modules + joining kit

£2583.00

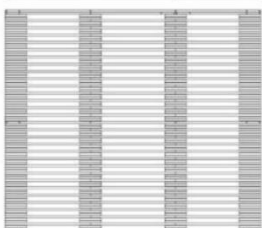
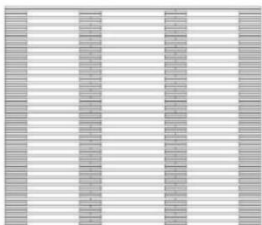

6' x 5' 5 29/32"
1830mm x 1674mm

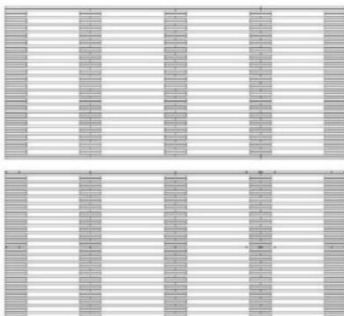

8' x 3' 8 41/64"
2440mm x 1134mm

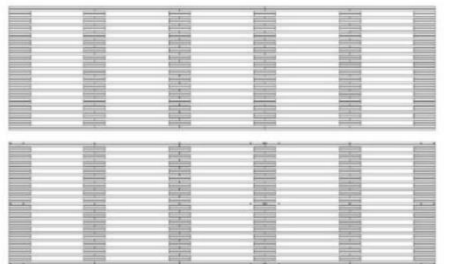

10' x 3' 9/64"
3050mm x 918mm



4' x 7' 7 27/64"
1220mm x 2322mm

7 modules + joining kit

£2958.50



4' x 8' 8 11/64"
1220mm x 2646mm

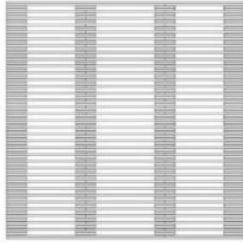

6' x 6' 2 13/32"
1830mm x 1890mm

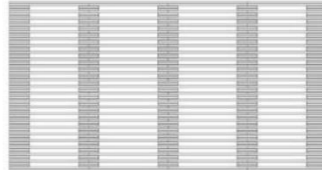

8' x 4' 5 5/32"
2440mm x 1350mm

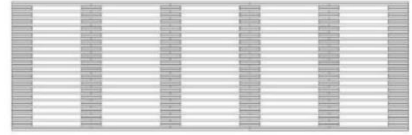
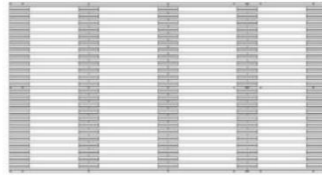

10' x 3' 4 25/64"
3050mm x 1026mm

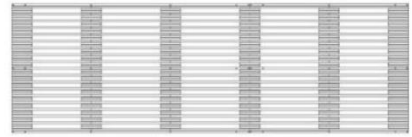

8 modules + joining kit
£3334.00



4' x 9' 8 59/64"
1220mm x 2970mm

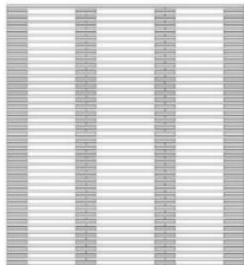

6' x 6' 10 29/32"
1830mm x 2106mm

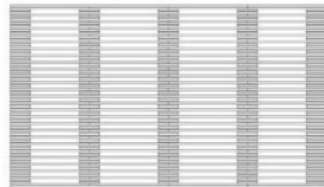
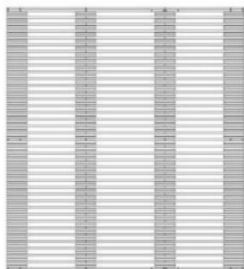

8' x 4' 9 13/32"
2440mm x 1458mm



10' x 3' 8 41/64"
3050mm x 1134mm



9 modules + joining kit
£3709.50

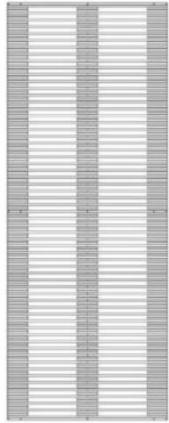

4' x 10' 9 11/16"
1220mm x 3294mm

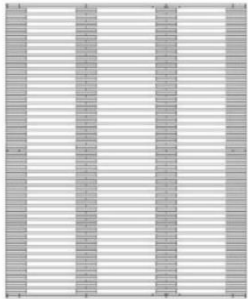
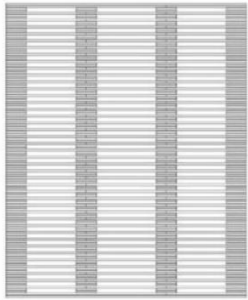

6' x 7' 7 27/64"
1830mm x 2322mm

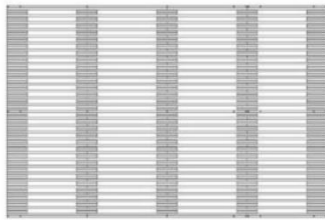
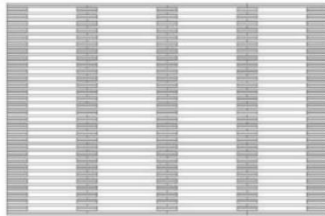

8' x 5' 5 29/32"
2440mm x 1674mm

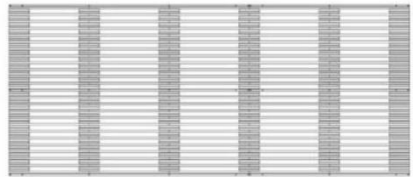
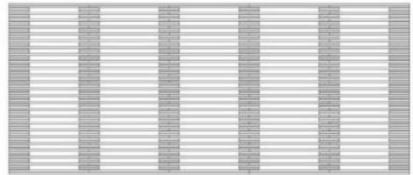

10' x 4' 5 5/32"
3050mm x 1350mm

10 modules + joining kit

£4085.00



4' x 11' 9 1/32"
1220mm x 3582mm

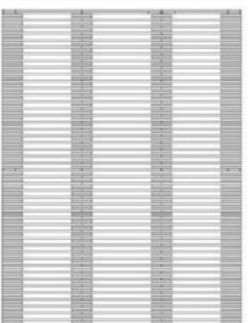
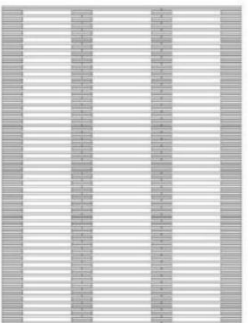

6' x 8' 3 5/32"
1830mm x 2583mm

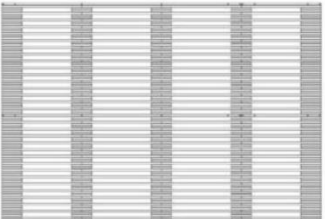
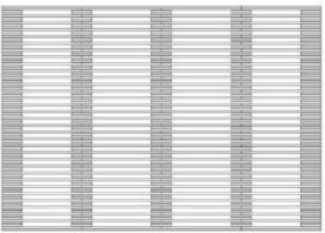

8' x 5' 10 5/32"
2440mm x 1782mm

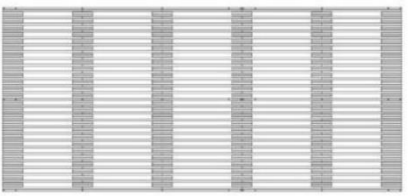
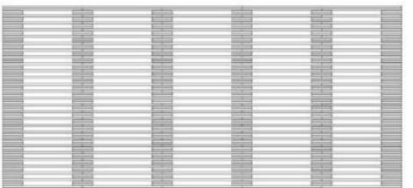

10' x 4' 9 13/32"
3050mm x 1458mm

11 modules + joining kit

£4460.50

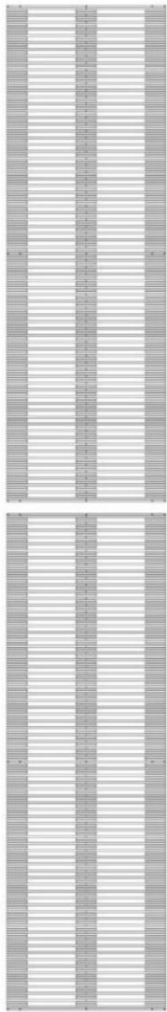

4' x 12' 11 13/64"
1220mm x 3942mm

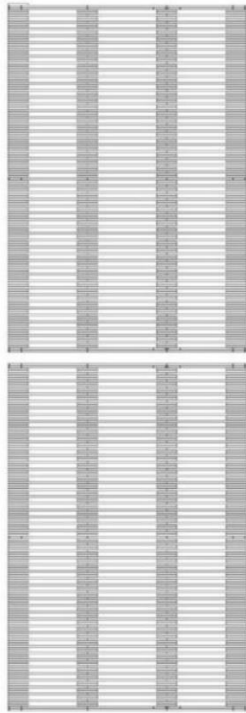

6' x 9' 27/64"
1830mm x 2754mm

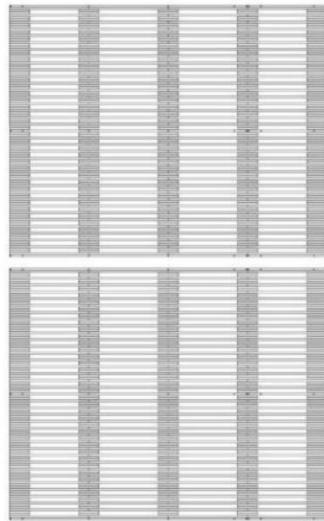

8' x 6' 6 21/31"
2440mm x 1998mm

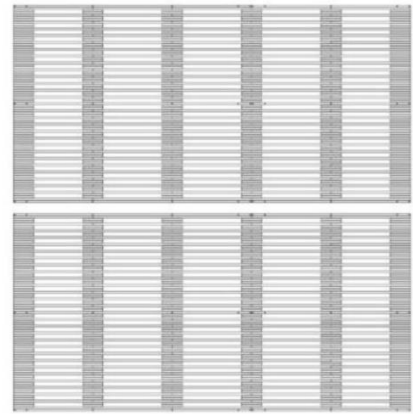

10' x 5' 1 17/64"
3050mm x 1556mm

12 modules + joining kit
£4836.00

Small radius module: £421.60

Made up from 9mm and 25° in 1' and 2' lengths.
Allows you to make any 2' long, 90° bend
between 185mm and 40mm radius.

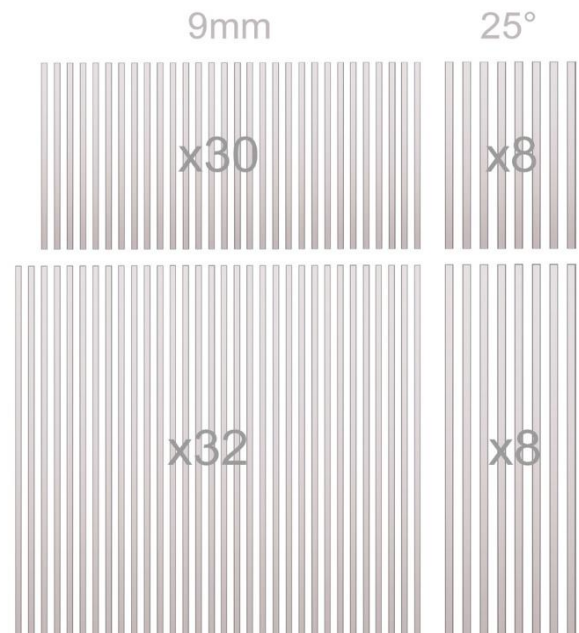
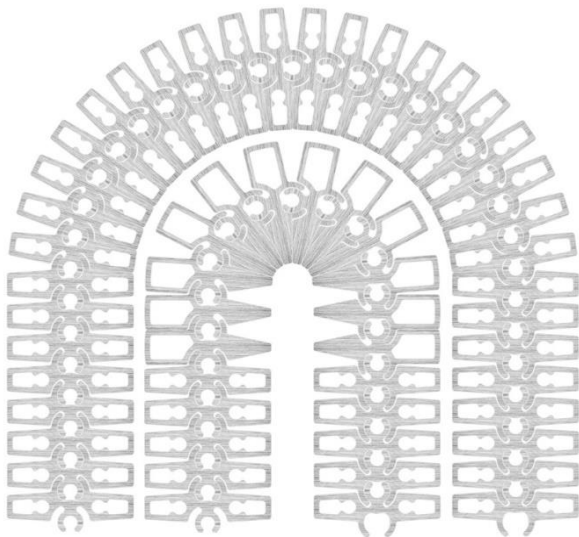

Payment, Taxes and Delivery charges

All prices shown are in Pounds Sterling and exclude UK VAT. If you are not in the UK then you may have to pay local import tax.

Delivery within mainland UK takes 7 working days and is free on orders over £200.

European delivery is by road haulage and usually takes 15-20 working days.

We are happy to deliver anywhere in the World where possible.

Charges apply for all international deliveries but these are at discounted rates.

Payment is taken by bank transfer